



PULSE POWER FORMULARY

Richard J. Adler

North Star Research Corporation

August, 1989 and March, 2001

Revised, August, 1991, June, 2002

Contributors:

I.D. Smith, Pulse Sciences, Inc.
R.C. Noggle, Rockwell Power Systems
G.F. Kiuttu, Mission Research Corporation

Supported by

The Air Force Office of Scientific Research
and
North Star Research Corporation

North Star High Voltage
12604 N New Reflection Dr
Marana AZ 85653
(520)780-9030; (206)219-4205 FAX
www.highvoltageprobes.com



North Star High Voltage
 12604 N New Reflection Dr
 Marana AZ 85653
 (520)780-9030; (206)219-4205 FAX
Highvoltage@Highvoltageprobes.com
www.highvoltageprobes.com



PVM Series Portable High Voltage Probes to 60 kV DC

PVM series high voltage probes are designed for general use, and for exceptional high frequency response. The probes have applications ranging from automotive ignition to excimer laser system measurement to EMI measurement. They are factory calibrated, and they do not require adjustment. An optional switch which can compensate for various measurement instruments such as 10 Megohm meters and 1 megohm oscilloscopes is available. These units are intended for a wide range of applications where portability and ease of use are essential.

Model Number	PVM-1	PVM-2	PVM-3	PVM-4	PVM-5	PVM-6	PVM-11 (PVM-10)	PVM-12
Max DC/Pulsed V (kV)	40/60	40/60	40/60	40/60	60/100	60/100	10/12	25/30
Max Frequency (Mhz.)	80	80	40	110	80	80	60	80
Cable Impedance (ohms)	50	50	50	93	50	50	93	50
DC - 2 Hz.accuracy	<0.1%	<0.1 %	<0.2 %	<0.1 %	<0.2%	<0.2%	<0.1 %	<0.1 %
2 Hz. - 200 Hz. accuracy	<1 %	<1. %	<2. %	<1. %	<1%	<1%	<1.5 %	<1.5 %
200 Hz. - 5 Mhz. accuracy	<1.5%	<1.5%	<3%	<1.5%	<1.5 %	<1.5 %	<2.%	<2.%
> 5 Mhz. Accuracy	<3%	<3%	<4%	<5%	<3%	<4%	<4%	<4%
Input R/C (Megohm/pf)	400/13	400/13	400/10	400/10	400/12	400/12	50/15	150/7
Cable Length (ft./m)	15/4.5	30/9	100/30	15/4.5	15/4.5	30/9	15/4.5	15/4.5
Standard Divider Ratio	1000:1	1000:1	10,000:1	1000:1	1,000:1	1,000:1	1,000:1 (100:1)	1,000:1
Length (inches/cm.)	15/38	15/38	15/38	15/38	19/45	19/45	7/18	9/23



North Star High Voltage
 12604 N New Reflection Dr
 Marana AZ 85653
 (520)780-9030; (206)219-4205 FAX
Highvoltage@Highvoltageprobes.com
www.highvoltageprobes.com

VD Series High Voltage Probes 60 to 300 kV DC



VD series high voltage probes are floor standing high voltage probes which are designed for rugged day in - day out use. They are used in a wide range of applications ranging from television tube manufacturing to radar to advanced particle accelerator applications. Resistors with an extremely low voltage coefficient of resistance are used, and all capacitors are temperature, frequency, and voltage stabilized for the best possible performance. The probes all have field defining toroids as a standard item in order to minimize the proximity effect (stray capacitance) and maximize the reproducibility of the measurement. The high and low frequency calibrations are carefully matched before shipment. Very high frequency cable effects are also carefully compensated so accurate measurements can be made even when the cable length exceeds the pulse duration. No adjustments are necessary once the probes have been factory calibrated.

Model Number	VD-60	VD-100	VD-150	VD-200	VD-300
Max DC/Pulsed V (kV)	60/120	100/200	150/280	200/300	300/400
Max Frequency (Mhz.)	20	20	20	16	12
Cable Length (ft.)	30	30	30	30	30
DC accuracy	<0.1 %	<0.1 %	<0.1%	<0.1%	<0.1 %
10 Hz. - 1 Mhz. Accuracy	1 %	1 %	1 %	1%	1 %
1 Mhz. - 20 Mhz. Accuracy	3 %	3 %	3 %	3%	3 %
Resistance (Megohms)	800	1600	2000	2800	4500
Height (inches/cm.)	19/48	26/67	30/74	40/99	57/137
Diameter (in/cm.)	12/29	12/29	12/29	16/40	24/61
Capacitance (approx. pf)	27	25	27	24	20
Base Diameter(in/cm.)	10/25	10/25	12/30	14/35	24/61
Standard Divider Ratio	10,000:1	10,000:1	10,000:1	10,000:1	10,000:1



North Star High Voltage
 12604 N New Reflection Dr
 Marana AZ 85653
 (520)780-9030; (206)219-4205 FAX
Highvoltage@Highvoltageprobes.com
www.highvoltageprobes.com

Thyratron Driver Boards

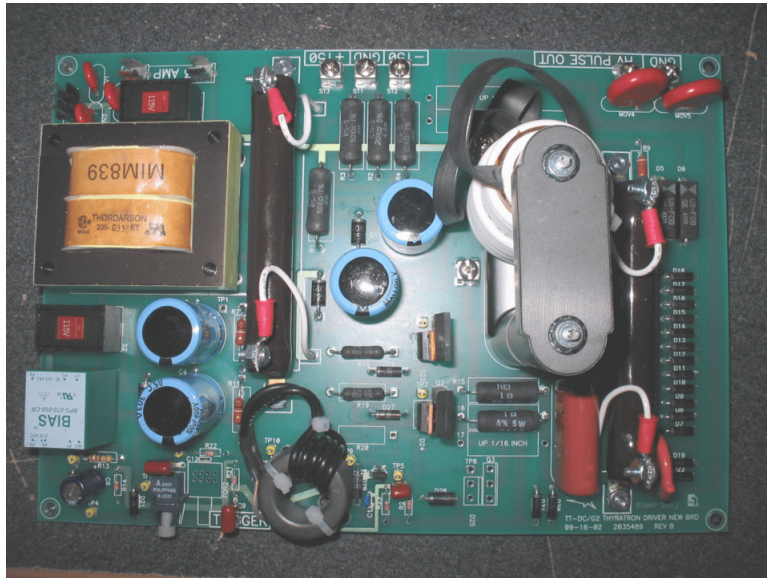

North Star High Voltage offers thyratron driver boards without chassis for general purpose use. These boards are generally combined by the user with reservoir and heater circuits to make a complete driver package. The board can then be mounted in the same enclosure with the other support circuits.

Extensive passive protection is provided for the board supported by a unique test program for the boards.

Model Number	TT-G2	TT-DC/G2	TT-G1/G2	TT-S (special order only)
G2 Open Voltage Pulse (kV)	2	2	2	0.8
G2 DC Bias (V)	0	-150 - -200	-150 - -200	-150 - -200
G2 Closed Current (A)	30	30	30	N/A
Std Rep Rate	400	400	400	400
Burst Rep Rate (Hz)	600	600	600	600
Custom Rep Rate (Hz)	>1000	>1000	1000	>1000
G1 Open Voltage (V)	150-200	150-200	500	N/A
G1 Closed Current	N/A	0.1	30	<5%
BNC/Plastic Fiber Adapter	Included	Included	Included	Included
Std. Input Type	Plastic Fiber	Plastic Fiber	Plastic Fiber	Plastic Fiber
Custom Input Type	ST/SMA	ST/SMA	ST/SMA	ST/SMA
Power Input	110/220 Select	110/220 Select	110/220 Select	110



North Star High Voltage
 12604 N New Reflection Dr
 Marana AZ 85653
 (520)780-9030; (206)219-4205 FAX
Highvoltage@Highvoltageprobes.com
www.highvoltageprobes.com

Ignitron Drivers



Ignitrons provide a unique high current switching capability for lasers, metal forming machinery, and a variety of capacitive discharge equipment. The IG5 unit meets or exceeds all ignitron requirements. It is delivered in a die cast aluminum box with convenient mounting studs. Only line power and a trigger are required for trigger pulse production.

The IG5 is provided with a DC “ready” status indicator, and a current based trigger indicator for useful feedback. We include protection networks for ringing discharge protection for all IG5-F units and the customer can use this feature or not depending on the type of discharge.

Model Number	IG5-F	IG5-F (Protected)	IG5-F-HC
Open Circuit Voltage Pulse (kV)	1.8	1.8	1.4
Ignitor Peak Current (A, typ)	380	260	380
Closed Circuit Current (A)	400	280	575
Std Rep Rate (Hz)	2	2	2
Energy Stored (J)	3.60	3.60	3.60
Std. Fiber Optic Length (m)	10	10	10
BNC/Plastic Fiber Adapter	Included	Included	Included
Std. Input Type	Plastic Fiber	Plastic Fiber	Plastic Fiber
Custom Input Type	ST/SMA	ST/SMA	ST/SMA
Power Input	110/220	110/220	110/220

1.0 FUNDAMENTAL CONSTANTS	5
2.0 DIMENSIONS AND UNITS	6
2.1 MKS-CGS-English Mechanical Unit Conversions	7
2.2 Color Code	7
3.0 CIRCUIT EQUATIONS	8
3.1 Model Circuit Results	8
3.1.1 LRC Circuit with Capacitor Charged Initially	8
3.2 Marx Generators	10
3.3 Capacitor Charging Circuits	12
3.3.1 Resistive Capacitor Charging, Constant Voltage Power Supply	12
3.3.2 Resonant Charging	13
3.4 Energies and Energy Densities	13
3.5 Transformer Based Application Circuits	14
3.5.1 Transformer Equivalent Circuit	14
3.5.2 Generalized Capacitor Charging	15
3.6 Magnetic Switching	16
4.0 TRANSMISSION LINES AND PULSE FORMING NETWORKS	17
4.1 Discrete Pulse Forming Networks	17
4.2 Transmission Line Pulse Generators	18
5.0 ELECTRICITY AND MAGNETISM	19
5.1 Transmission Line Relationships-General as Applied to Pulse Generation:	19
5.2 Skin Depth and Resistivity	20
5.3 Field Enhancement Functions in Various Geometries	22
6.0 MATERIALS PROPERTIES	24
6.1 Solid Dielectric Properties	24
6.2 Gas Properties	25
6.3 Liquid Breakdown	26
6.4 Vacuum Insulation and Surface Flashover	27
6.5 Conductor Properties	28
6.5.1 Wire Data--Standard Sizes of Copper Wire	29
6.6 Components	30
6.6.1 Capacitors	30
6.6.2 Resistors	31
7.0 APPLICATIONS	32
7.1 Intense Electron and Ion Beam Physics	32

7.2 Electron Beam/Matter Interaction	35
7.3 High Power Microwaves	36
7.4 Railguns	37
8.0 DIAGNOSTICS	39
8.1 Sensitivity of an Unintegrated Square Current Loop	39
8.2 Rogowski Coil	39
8.3 Current Transformer	40
8.4 Attenuators	40
9.0 MECHANICAL DATA	41
9.1 Coarse Screw Threads	41
9.2 Fine Threads	42
9.3 Deflection of Beams	43
10.0 REFERENCES	44

Introduction

The purpose of this document is to serve the user of pulse power in the variety of tasks which he or she faces. It is intended to be used as a memory aid by the experienced pulse power engineer, and as a record of pulse power facts for those with less experience in the field, or for those who encounter pulse power only through their applications. A great deal of pulse power work involves the evaluation of distinct approaches to a problem, and a guide such as this one is intended to help speed the calculations required to choose a design approach.

In the formulary, we strived to include formulae which are 'laws of nature' such as the circuit equations, or well established conventions such as the color code. We have purposely avoided listing the properties of commercial devices or materials except where they may be regarded as generic. This has been done so that the formulary will not become obsolete too quickly. The formulas have intentionally been left in their original form, so that the use of the formulary tends to reinforce one's natural memory.

We hope to expand this document, particularly by adding new applications areas. A section on prime power systems would also be desirable. Any suggestions on formulas which have been omitted or misprinted would be appreciated.

The author would also like to thank W. Dungan and B. Smith of the US Air Force, W. Miera of Rockwell Power Systems, and J. Bayless and P. Spence of Pulse Sciences, Inc. for encouragement over the course of this and previous formula compilation efforts.

Finally, we note that few written works are without error, and that even correct information can be misinterpreted. North Star Research Corporation and the US Air Force take no responsibility for any use of the information included in this document, and advise the reader to consult the appropriate references and experts in any pulse power venture.

This work was supported by the US Air Force Office of Scientific Research under contract F49620-89-C-0005.

NOTE: EXPONENTS ARE PLACED IN BRACKETS AT THE END OF A NUMBER

EXAMPLE: $2.5(7) = 2.5 \times 10^7$

1.0 FUNDAMENTAL CONSTANTS

Nomenclature: note that numbers in brackets are base 10 exponents

Example: $1.26 \times 10^{-6} = 1.26(-6)$

SYMBOL	NAME	VALUE-MKS(exp)	VALUE-CGS(exp)
c	Speed of light	2.9979(8)m/s	2.9979(10)cm/s
e	Electron charge	1.6022(-19)C	4.803(-10)esu
ϵ_0	Free Space Permittivity	8.8541(-12)F/m	1
μ_0	Free Space Permeability	1.2566(-6)H/m	1
h	Planck's Constant	6.6261(-34)J-S	6.6261(-27)erg-s
m_e	Electron mass	9.1094(-31)kg	9.1094(-28)g
m_p	Proton mass	1.6726(-27)kg	1.6726(-24)g
amu	Atomic mass unit	1.6605(-27)kg	1.6605(-24)g
e/m_e	Electron charge/mass	1.7588(11)C/kg	5.2728(17)esu/g
m_p/m_e	p/e mass ratio	1.8362(3)	-----
k	Boltzman constant	1.3807(-23)J/K	1.3807(-16)erg/K
N_B	Avogadro constant	6.0221(23)mol ⁻¹	-----
σ	Stefan-Boltzman constant	5.671(-8)W/m ² K ⁴	5.671(-5)
n_0	Loschmidt constant	2.6868(25)m ⁻³	2.6868(19)cm ⁻³
atm	Standard Atmosphere	1.0132(5)Pa	1.0125(6)erg/cm ³
g	Gravitational Const.	9.8067Kg/m/s ²	9.8067(5)gcm/s ²

Units:

m=meter	cm=centimeter	s=second	q =coulomb=Amp-s
esu=electrostatic unit	F=Farad	H=henry	J=Joule=kg-m ² /s ²
kg=kilogram	g=gram	erg=g-cm ² /s ²	
K=degree Kelvin	Pa=Pascals=Kg/ms ²		

Energy Equivalence Factors

$$1 \text{ kg} = 5.61(29) \text{ MeV} \quad 1 \text{ amu} = 931.5 \text{ MeV} \quad 1 \text{ eV} = 1.602(-19) \text{ J}$$

$$\lambda(\text{m}) = 1.2399(-6)/W(\text{eV}) \quad W = \text{Photon Energy and } \lambda \text{ is the wavelength}$$

2.0 DIMENSIONS AND UNITS

In order to convert a number in MKS units into Gaussian units, multiply the MKS number by the Gaussian conversion listed. The number 3 is related to c and for accurate work is taken to be 2.9979. In this work numbers in parentheses are base 10 exponents.

Physical Quantity	Sym- bol	Dimensions SI(MKS)	Dimensions Gaussian	SI Units	Gaussian Conversion	Gaussian Units
Capacitance	C	t^2q^2/ml^2	l	farad	9(11)	cm
Charge	q	q	$m^{1/2} l^{3/2}/t$	coulomb	3(9)	statcoul.
Conductivity	σ	tq^2/ml^3	1/t	siemens/m		9(9) sec ⁻¹
Current	I	q/t	$m^{1/2} l^{3/2}/t^2$	ampere	3(9)	statamps
Density	ρ	m/l^3	m/l^3	kg/m ³	1(-3)	gm./cm ³
Displacement	D	ql^2	$m^{1/2}l^{1/2}t$	coul./m ²	12 π (5)	stat-coul./cm ²
Electric field	E	$m l/t^2q$	$m^{1/2}l^{1/2}t$	volt/m	(1/3)(-4)	statvolt/cm
Energy	U,W	$m l^2/t^2$	$m l^2/t^2$	joule	1(7)	erg
Energy density	w, ϵ	$m/l t^2$	$m/l t^2$	joule/m ³	10	erg/cm ³
Force	F	$m l/t^2$	$m l/t^2$	newton	1(5)	dyne
Frequency	f	t^{-1}	t^{-1}	hertz	1	hertz
Impedance	Z	$m l^2/tq^2$	t/l	ohm	(1/9)(-11)	sec/cm
Inductance	L	$m l^2/q^2$	t^2/l	henry	(1/9)(-11)	sec ² /cm
Length	l	l	l	meter(m)	1(2)	cm
Magnetic intens.	H	q/l t	$m^{1/2}l^{1/2}t$	amp-trn/m	4 π (-3)	oersted
Magnetic induct.	B	m/tq	$m^{1/2}l^{1/2}t$	tesla	1(4)	gauss
Magnetization	M	q/l t	$m^{1/2}l^{1/2}t$	amp-trn/m	1(-3)	oersted
Mass	m,M	m	m	kilogram	1(3)	gram(g)
Momentum	p,P	m l/t	m l/t	kg-m/sec	1(5)	g-cm/sec
Permeability	μ	$m l/q^2$	1	henry/m	1/4 π (7)	-
Permittivity	ϵ	t^2q^2/ml^3	1	farad/m	36 π (9)	-
Potential	V, Φ	$m l^2/t^2q$	$m^{1/2}l^{1/2}t$	volt	(1/3)(-2)	statvolt
Power	P	$m l^2/t^3$	$m l^2/t^3$	watt	1(7)	erg/sec
Pressure	p	$m/l t^2$	$m/l t^2$	pascal	10	dyne/cm ²
Resistivity	ρ	$m l^3/tq^2$	t	ohm-m	(1/9)(-9)	sec
Temperature	T	K	K	Kelvin	1	Kelvin
Thermal cond	κ	$m l/t^3K$	$m l/t^3K$	watt/m-K	1(5)	erg/cm-sec-K
Time	t	t	t	sec.	1	sec.
Vector pot.	A	$m l/tq$	$m^{1/2}l^{1/2}t$	weber/m	1(6)	gauss-cm

2.1 MKS-CGS-English Mechanical Unit Conversions

Multiply English value by "Conversion" to obtain value in MKS units.

Quantity	MKS(SI)	English	Conversion
Length	m	foot (ft)	0.305 m/ft
Mass	kg	slug	14.593 kg/slug
Time	sec	sec	
Linear velocity	m/sec	ft/sec	0.305 m/ft
Angular velocity	rad/sec	rad/sec	
Linear momentum	kg-m/sec	slug-ft/sec	0.00430
Linear acceleration	m/sec ²	ft./sec ²	0.305
Angular acceleration	rad/sec ²	rad/sec ²	
Force	Newton	pound (lb)	4.4481 nt/lb
Work	Nt-m	ft-lb	1.356 Nt /lb-ft
Energy	Joule	ft-lb	1.356 J/ft
Power	watt	horsepower	747 W/hp
Weight	Kilogram	lb.	0.4536

2.2 Color Code

Color	Number or Tolerance (%)	Multiplier
Black	0	1
Brown	1	10
Red	2	100
Orange	3	1000
Yellow	4	10,000
Green	5	100,000
Blue	6	1,000,000
Violet	7	10,000,000
Gray	8	100,000,000
White	9	1,000,000,000
Silver	5%	0.01
Gold	10%	0.1

Resistors:

First band = first digit;

Second band = second digit

Third band = multiplier (or number of zeroes);

Fourth band = tolerance

3.0 CIRCUIT EQUATIONS

3.1 Model Circuit Results

3.1.1 LRC Circuit with Capacitor Charged Initially

This is the basic pulse power energy transfer stage, and so is solved in detail. An important limit is the LRC circuit with a single charged capacitor, and that circuit is the C_2 goes to infinity limit of the 2 capacitor circuit.

$$\tau = L/R$$

$$C = C_1 C_2 / (C_1 + C_2)$$

$$\omega_o^2 = 1/LC$$

$$\omega^2 = \text{ABS}(1/LC - 1/(2\tau)^2)$$

$$V_o = \text{initial } C_1 \text{ voltage}$$

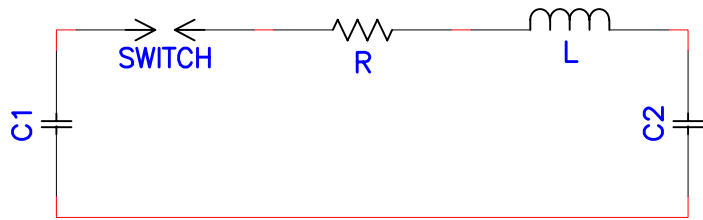

1) Oscillatory Case

$$R^2 < 4L/C \text{ (underdamped)}$$

$$I = (V_o/\omega L)\exp(-t/2\tau)\sin\omega t$$

$$I(\text{maximum}) \simeq V_o/((L/C)^{1/2} + 0.8R)$$

$$V(C_2) = \text{'output voltage'}$$

$$= [V_o C_1 / (C_1 + C_2)] \{1 - \exp(-t/2\tau)\cos\omega t + (1/2\omega\tau)\exp(-t/2\tau)\sin\omega t\}$$

$$V(C_1) = V_o C_1 / (C_1 + C_2) + V_o C_2 e^{-t/2\tau} (\cos\omega t + (1/2\omega\tau)\sin\omega t) / (C_1 + C_2)$$

$$V(C_2 \text{ maximum}) = [V_o C_1 / (C_1 + C_2)] \{1 + \exp(-\pi/2\omega\tau)\}$$

$$V(C_1 \text{ minimum}) = [V_o / (C_1 + C_2)] \{C_1 - C_2 \exp(\pi/2\omega\tau)\}$$

$$Q = (L/C)^{1/2}/R = \text{Circuit Quality Factor}$$

2) Energy transfer to C_2 as a fraction of original C_1 energy η

$$\eta = [4C_1 C_2 / (C_1 + C_2)^2] \{1 - \exp(-\pi/2\omega\tau)\}^2$$

Efficiency of lossless energy transfer from C_1 to C_2 .

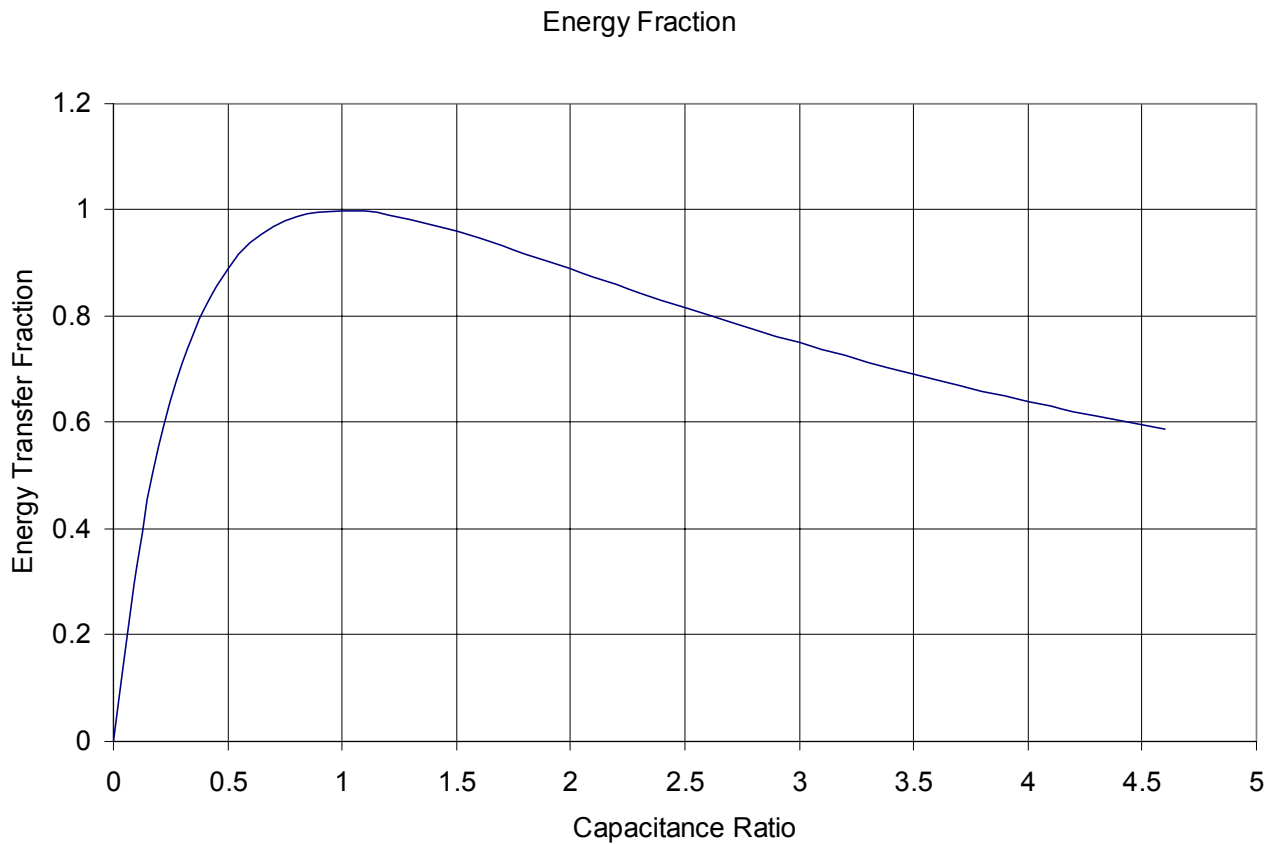

3) Overdamped case

$$R^2 > 4L/C$$

$$I = \{V_o \exp(-t/2\tau) / 2L\omega\} [\exp(+\omega t) - \exp(-\omega t)]$$

$$V(C_2) = (V_o / 2C_2 L \omega) \{ 2 \omega / \omega_o^2 - \exp(-t/2\tau) [\{ \exp(-\omega t / (\omega + (1/2\tau))) \} + \{ \exp(\omega t) / ((1/2\tau) - \omega) \}] \}$$

3) Shunt resistance (Underdamped) may be important in the case of water capacitors or the charge resistors in Marx generators. For the underdamped case, a resistance shunting C_2 of value R_{sh} may be included in the output voltage equation as given below:

$$V(C_2) = [V_o C_1 / (C_1 + C_2)] \{ \exp(-t/R_{sh}(C_1 + C_2)) - \exp(-(t/2\tau + t/2R_{sh}C_2)) [\cos \omega t + (1/2\omega\tau) \sin \omega t] \}$$

3.2 Marx Generators

3.2.1 Conventional Marx

$$\begin{aligned}
 N &= \text{Number of capacitor stages} \\
 C_2 &= \text{Capacitance to be charged} \\
 L &= L_{\text{switches}} + L_{\text{caps}} + L_{\text{connections}} \\
 R_s &= R_{\text{switches}} + R_{\text{caps}} \\
 \tau &= L/R_s \\
 C &= \text{Capacitance of single stage} \\
 \omega^2 &= ((NC_2 + C)/(NLCC_2) - 1/(2\tau)^2)
 \end{aligned}$$

Capacitive load = C_2

$$V(C_2 \text{ max}) = [2NV_o C / (C + NC_2)] \{1 - \exp(-\pi / 2\omega\tau)\}$$

Losses when charging E_l with resistance R or inductance L_c per stage for N stages:

$$E_l = N(V_o^2/R)(\pi/\omega)$$

$$E_l = N(V_o^2/L_c)(\pi/2\omega)^2 \text{ approximately, or use the data of section 3.1.1 where } C_1 = C/N.$$

Resistive load R_L , where $R_s = R_L$ plus the sum of all other series circuit resistances

$$\begin{aligned}
 \omega^2 &= ((R_s/2L)^2 - N/(LC)) \\
 \tau &= L/R_s
 \end{aligned}$$

$$V_{\text{out}} = (NV_o R_L \exp(-t/2\tau) / 2L\omega) [\exp(+\omega t) - \exp(-\omega t)]$$

$$T_m = (1/2\omega) \ln[(1 + 2\omega\tau)/(1 - 2\omega\tau)] = \text{time at which voltage is peak}$$

Losses due to charging components for inductive and resistive charging during the discharge--specifically energy dissipation in the $2N$ charge resistors R during the pulse, or energy left in the $2N$ charge inductors L_c at the end of the pulse:

$$E_l = NV_o^2 R_s (R_s^2 C / 2L - 1) / (R [(R_s^2 / 4L) - N/C])$$

$$E_l = (V_o (R_L + R) C)^2 / NL_c$$

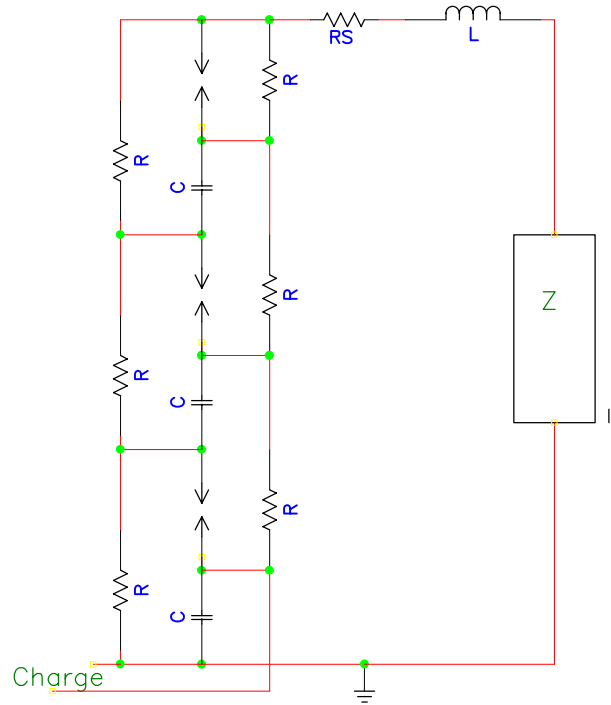

Peaking circuit

Peaking circuits are used in order to get fast rise times from Marx based circuits for applications such as EMP testing. In EMP testing, an exponential waveform with a very fast rise time is required. Note that source resistances are ignored in this treatment, and that these may be included by referring to the treatment of 3.1.1.

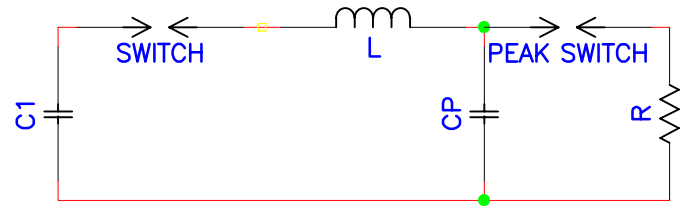

$$C_p = (L/R^2)/(1+(L/R^2C_1))$$

is the peaking capacitance required to give an exactly exponential decay through the load resistance R. The switch is arranged to fire when the current is maximum at

$$t = (LC_p C_1 / (C_1 + C_p))^{1/2} \cos^{-1}(C_p / C_1)$$

LC Marx

'Vector Inversion Type'

Open circuit voltage

$$\omega^2 = 1/LC, \tau = L/R$$

$$V = (nV/2)(1 - \exp(-t/2\tau)\cos\omega t)$$

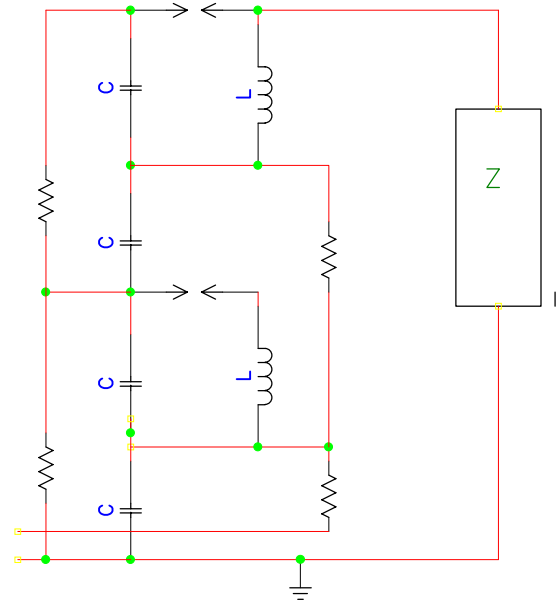

3.3 Capacitor Charging Circuits

<u>TYPE</u>	<u>Application</u>	<u>Advantages</u>	<u>Disadvantages</u>
Resistive, No filter Capacitor	Low voltage, Small Caps.	Simple	Low eff. (50%)
Inductive	Pulse charging	Efficient Doubles voltage	Requires store capacitor, 1st pulse half voltage
Pulse Transformer	High voltage pulse charging	Efficient	Complex, Expensive
Resonant Pulse	High voltage pulse charging	Efficient	Complex, Capacitors undergo reversal
AC resonant	Pulse charge	Efficient	Not versatile
Switcher	All	Efficient	

3.3.1 Resistive Capacitor Charging, Constant Voltage Power Supply

R = charge resistance
 V_o = power supply voltage
 C = capacitance to be
 charged

$$V(t) = V_o (1 - e^{-t/RC})$$

$$I(t) = V_o e^{-t/RC}$$

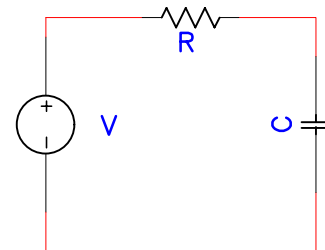

V/V_o (%)	t/RC
50	0.7
75	1.4
90	2.3
95	3.0
99	4.6
99.9	6.9

3.3.2 Resonant Charging

- C_1 = Storage capacitance
- C_2 = Load capacitance
- L = Charging inductance
- V_1 = Initial voltage on C_1
- $\omega^2 = (C_1 + C_2)/LC_1C_2$
- V_2 = Final voltage on C_2

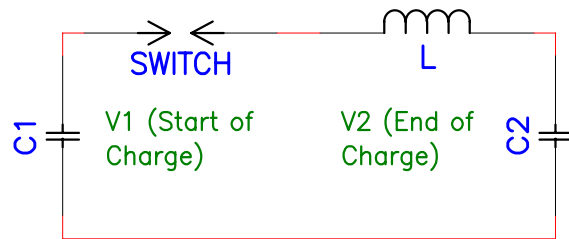

$I(t) = (V_1/\omega L)\sin\omega t$, where

$V_2(t) = V_1(C_1/(C_1 + C_2)) (1 - \cos \omega t)$

$V_{2max} = GV$, where ringing gain, $G = 2C_1/(C_1+C_2)$

also see section 3.1.1

Inductive store charging a capacitance using an opening switch

- I_0 = Initial Current
- $\omega^2 = LC - (1/4R^2C^2)$
- $\tau = RC$
- R = Circuit total Resistance
- C = Capacitance to be charged

$V_2(t) = (I_0/\omega C)\exp(-t/2\tau)\sin\omega t$

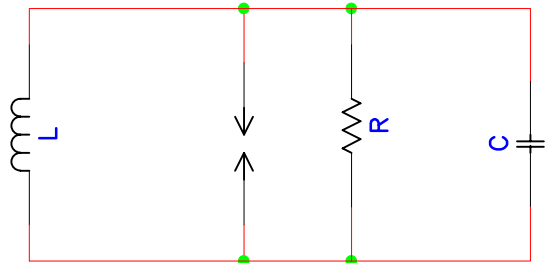

3.4 Energies and Energy Densities

Energy of a capacitor (Joules) $CV^2/2$
 C = Capacitance (F), V = Voltage (Volts) or

Energy of an inductor (Joules) $LI^2/2$
 L = Inductance (H), I = Current (Amperes)

Energy formulae also give results in joules for units of μF , μH , kV , kA

Energy density of an E field (J/m^3) $\epsilon E^2/2$
 ϵ =permittivity(F/m), E = Elect. field (V/m)

Energy density of a magnetic field (J/m^3) $\mu B^2/2$
 μ =permeability (H/m), B =magnetic field (T)

3.5 Transformer Based Application Circuits

3.5.1 Transformer Equivalent Circuit (suggested by I.D. Smith)

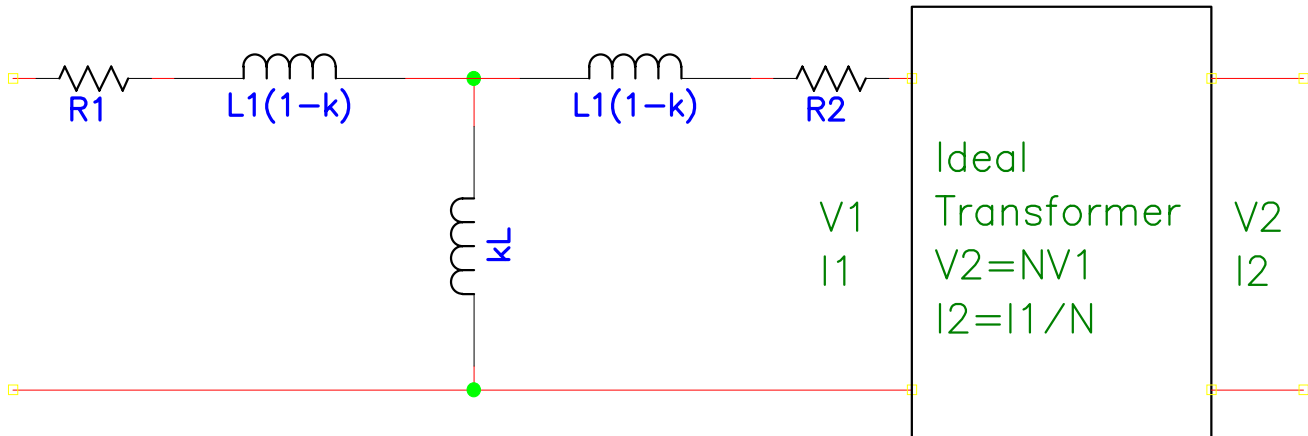

A number of transformer equivalent circuits exist, and they often differ in their details. In particular, many of the circuits are unable to treat coupling coefficients much less than 1. For transformers made from sheets, the relative current distribution in the sheet must be assumed to remain fixed in time for this model to be appropriate. In making measurements of equivalent circuit parameters, frequencies used must be close to those in actual use, and the effect of stray components must be quantified. For magnetic core transformers, measurements may need to be made in actual pulsed conditions since permeability can be a strong function of magnetizing current. The calculated turns ratio should be used instead of the counted turns ratio in the calculations below.

L_1 = Primary inductance (measured with the secondary open)

L_2 = Secondary inductance (measured with the secondary open)

M_1 = Mutual inductance referred to primary side

k = Coupling coefficient

R_1 = Primary series resistance

R_2 = Secondary series resistance

The equivalent circuit parameters are measured or computed as follows. All quantities are referred to the primary side except where indicated by an asterisk:

$$N = (L_2/L_1)^{1/2}$$

$$L_2 = L_2^*/N^2$$

L_{ps} = primary inductance with the secondary shorted = primary leakage inductance

L_{ss}^* = secondary inductance the primary shorted = secondary leakage inductance

$N^2 = L_{ss}^*/L_{ps}$ is a useful consistency check

$$R_2 = R_2^*/N^2$$

$$k = (1 - L_{ps}/L_1)^{1/2} = (1 - L_{ss}^*/L_2)^{1/2}$$

$$M^* = k(L_1 L_2^*)^{1/2}$$

$$M_1 = k(L_1 L_2)^{1/2}$$

l = Magnetic path length of core = $2\pi r$ for a toroidal core

H = Magnetization of the core = $(N_1 I_1 - N_2 I_2)/l$

Energy loss due to magnetizing current = $E = [VT]^2/2kL_1$ where VT is integrated Voltage-time product.

In general, the capacitances can be ignored in the circuit model unless the circuit impedance is high. Winding resistance (including skin losses) are usually important, as are the inductances.

3.5.2 Generalized Capacitor Charging

General capacitor charging relations for arbitrary coupling coefficient, and primary and secondary capacitances. Losses are assumed to be negligible in these formulae

Voltage on charging capacitor L_2 :

$$V_2 = kV_o(\cos s_1 t - \cos s_2 t)/[(L_1 L_2)^{1/2} C_2 \{\omega_1^4 - 2(1-2k^2)\omega_1^2 \omega_2^2 + \omega_2^4\}^{1/2}]$$

$$s_1^2, s_2^2 = (1/(2-2k^2))\{\omega_{12} + \omega_{12} \pm [\omega_1^4 - 2(1-2k^2)\omega_1^2 \omega_2^2 + \omega_2^4]^{1/2}\}$$

For $\omega_1 = \omega_2 = \omega$

$$V_2(t) = (L_1/L_2)^{1/2} (V_o/2) [\cos(\omega t/(1-k)^{1/2}) - \cos \omega t/(1+k)^{1/2}]$$

Dual Resonance occurs for $k = 0.6$, and V_2 is maximum at $t = 4/\omega$.

A family of dual resonance solutions exists for lower values of k , however, these are of less practical interest

3.6 Magnetic Switching

a = inner toroid diameter (m)

b = outer toroid diameter (m)

f = charge time/discharge time

E = energy in capacitor (joules)

$\delta B = B_r + B_s$

B_r = field at reset (tesla)

B_s = Saturation field (tesla)

g = packing fraction of magnetic material inside windings

N = number of turns

τ = charge time of the initial capacitor assuming inductively limited,
capacitor - capacitor charging (1 - cos ωt waveform)
= $\pi(LC/2)^{1/2}$ where L is the charging inductance

Minimal volume requirement for magnetic switching is that the relative magnetic permeability

$$\mu \gg f^2$$

$$U = \pi^3 \times 10^{-7} E f^2 Q / (\delta B g)^2$$

= Required switch volume (m³) for energy transfer between two equal capacitances

Q = 1 for strip type magnetic switches, or thin annulii

Q = ln(b/a)[(b+a)/2(b-a)] for general toroid case

$$N = \pi V \tau (b+a) / 2g \delta B U$$

4.0 TRANSMISSION LINES AND PULSE FORMING NETWORKS

4.1 Discrete Pulse Forming Networks

A variety of pulse forming networks have been developed in order to produce output pulses with a constant, or near constant amplitude for the pulse duration. The ideal physical transmission line may be approximated by an array of equal series inductors and capacitors as shown below. The examples below are optimized 5 element networks which produce the minimum amount of pulse ripple when charged and discharged. These pulse forming networks are discussed in great detail in the work of Glasoe and Lebacz. Negative inductances are not a misprint but reflect the results of calculations.

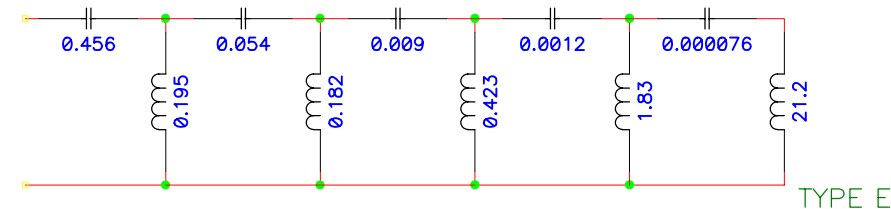
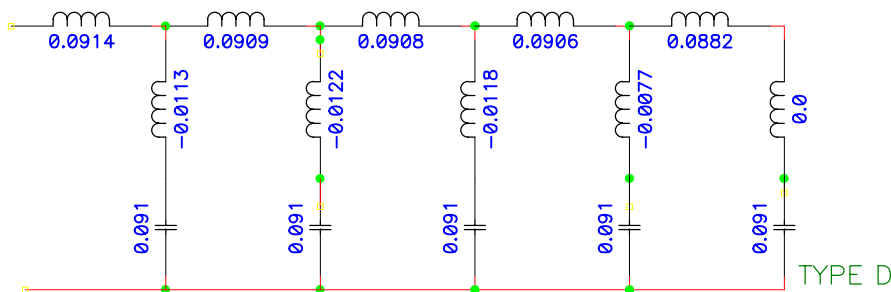
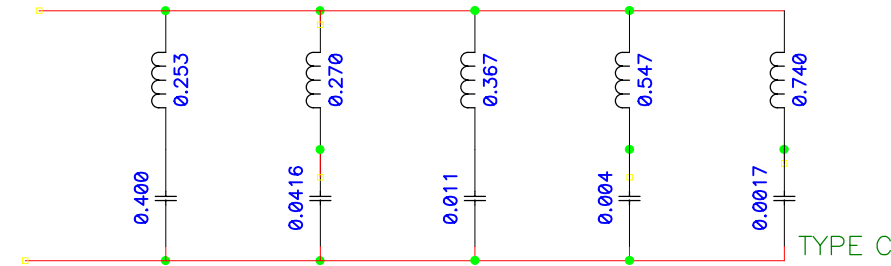
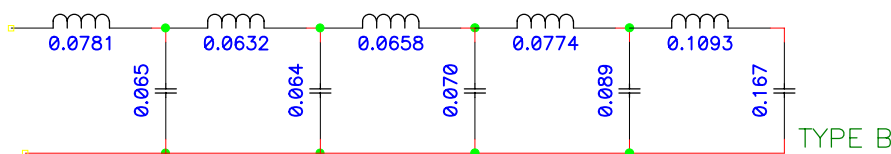
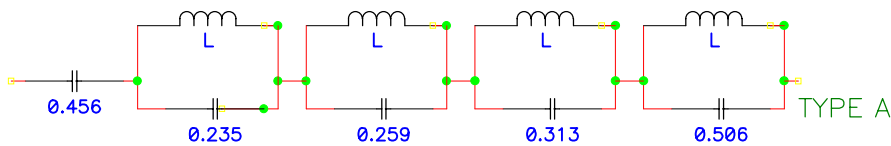

Five section Guilleman voltage-fed networks. Multiply the printed inductance values by Z_T , the capacitances by τ/Z where Z is the line impedance, and τ is the pulse duration. Zero mutual inductance is assumed in the calculations.

4.2 Transmission Line Pulse Generators

Ideal pulse line of impedance Z connected to a load of resistance R

V_o = open circuit voltage of the pulse line

$\tau = L/(Z + R)$

L = total inductance (switch + connections, etc.)

l = physical length of line for continuous line

$T = 2l\epsilon^{1/2}/c$

n = cycle number

ϵ = relative permittivity of the medium

$$I = V_o(1 - \exp(-t/\tau))/(Z + R)$$

$$V = V_o R(1 - \exp(-t/\tau))/(Z + R)$$

Rise time from .1 max V to .9 max $V = 2.2\tau$

The 'plateau' value of load voltage (ignoring rise time effects) changes at time intervals of T .
The n th amplitude (where n starts with 0) is:

$$V(t = nT + T/2) \simeq V_o R(R-Z)^n / (R + Z)^{n+1}$$

Blumlein response

Ideal Blumlein of impedance Z in each half line, with length l in each half

L = switch plus connection inductance

$\tau = L/Z$

n = cycle number

$$I_{sw} = 2V_o[1 - \exp(-t/\tau)]/Z$$

$$V = V_o R[1 - \exp(-t/\tau)]/(2Z + R)$$

$$V(t = 2nT + T/2) = V_o R(R - 2Z)^n / (R + 2Z)^{n+1}$$

$$V(t = 2nT + 3T/2) = 0$$

5.0 ELECTRICITY AND MAGNETISM

L, Inductance (Henries)

l , Length (m, meters)

$Z_o = 377 \text{ Ohms} = \mu_o / \epsilon_o$

$c = \text{Speed of light} = 3.0(8) \text{ m/sec}$

C, Capacitance (Farads)

Z, Impedance (Ω , Ohms)

ϵ , Rel. dielectric Const.

$\tau = 2l \epsilon^{1/2} / c = \text{Output pulse length of a distributed line}$

5.1 Transmission Line Relationships-General as Applied to Pulse Generation:

$$C = \epsilon^{1/2} l / Zc$$

$$C = \tau / 2Z$$

$$L = Z l \epsilon^{1/2} c$$

$$L = Z \tau / 2$$

$$(LC)^{1/2} = l \epsilon^{1/2} / c$$

$$\tau = 2(LC)^{1/2}$$

$$Z = (L/C)^{1/2}$$

Specific Common Transmission Lines

Coaxial, $a = \text{ID}$, $b = \text{OD}$, $Z = (Z_o / 2\pi \epsilon^{1/2}) \ln(b/a)$

Parallel Wires, $d = \text{wire diam}$, $D = \text{Wire center spacing}$ $Z = (Z_o / \pi \epsilon^{1/2}) \cosh^{-1}(D/d)$

Wire to ground, $d = \text{wire diam}$, $D = \text{Wire center-ground spacing}$

$Z = (Z_o / 2\pi \epsilon^{1/2}) \cosh^{-1}(2D/d) \sim (Z_o / 2\pi \epsilon^{1/2}) \ln(4D/d)$, for $D \gg d$

Parallel Plate, Width w , Separation d , $d < w$

$$Z \simeq Z_o d / \epsilon^{1/2} (d + w)$$

Circuit Parameter Formulas

Coaxial Inductor, $b = \text{OD}$, $a = \text{ID}$ $L = (\mu_o l / 2\pi) \ln(b/a)$

Solenoid,

$l = \text{solenoid length (m)}$

$r = \text{solenoid radius (m)}$

$n = \text{turns per meter, } N = ln$

$t = \text{solenoid thickness (m)}$

$z = \text{distance between field point and one end of solenoid (m)}$

$V = \text{Volume of the solenoid (m}^3\text{)}$

Ideal solenoid, where $l \gg r$

$$L = \mu_o n^2 l \pi r^2 = 1.26 n^2 l \pi r^2 = 4N^2 r^2 / l \text{ microhenries}$$

$$B = \text{mag. field (tesla)} = 1.26 \times 10^{-6} nI (\text{A})$$

$$P = (B^2 \rho / \mu_o^2) V (2t/r) = \text{Power dissipation of an ideal DC solenoid}$$

Shorter Solenoid or near ends

$$B = (\mu_o nI / 2) [z / (z^2 + r^2)^{1/2} + (l-z) / \{(l-z)^2 + r^2\}^{1/2}]$$

Magnetic Field of a Long Wire

r =distance from wire center(m), $B=(\mu_o/2\pi)I/r=200(I(\text{kiloamps})/r(\text{cm}))\text{gauss}$

Inductance of a Current Loop

$L = N^2(a/100)[7.353\log_{10}(16a/d)-6.386]$ microhenries

a =mean radius of ring in inches, d = diameter of winding in inches, and $a/d > 2.5$

5.2 Skin Depth and Resistivity

Skin depth δ is the depth at which a continuous, tangential sinusoidal magnetic field decays to $1/e$ times the incident field.

$$\omega=2\pi f$$

μ =permeability of medium

ρ =material resistivity ($\Omega\text{-m}$); $\rho_c = 1.7(-8)\Omega \text{ m}(\text{copper})$

$$\delta=(2\rho/\omega\mu)^{1/2}=(6.61/f^{1/2})((\mu_o/\mu)(\rho/\rho_c))^{1/2}$$

Resistance per square R_{sq} is the resistance of the surface for a length equal to the width at a given frequency

l = length

w = width

$$R = R_{sq}l/w$$

$$R_{sq} = \rho/\delta=(\omega\mu\rho/2)^{1/2}$$

$$R_{sq} = 2.61(-7)f^{1/2}((\mu/\mu_o)(\rho/\rho_c))^{1/2}$$

High frequency resistance of an isolated cylindrical conductor

D = Conductor diameter in inches

R_{ac} = Effective resistance for a CW ac wave

Note that R_{ac} is somewhat smaller for unipolar pulses than for ac.

If $Df^{1/2}(\mu_r\rho_c/\rho)^{1/2} > 40$:

$$R_{ac} \simeq (f^{1/2}/D)(\mu_r\rho/\rho_c)^{1/2} \times 10^{-6} \text{ ohms/ft.}$$

If $Df^{1/2}(\mu_r\rho_c/\rho)^{1/2} < 3$, then $R_{ac} \sim R_{dc}$

5.3 Field Enhancement Functions in Various Geometries

Cylindrical Geometry where X is the distance between two conductors, and r is the radius of the smaller conductor.

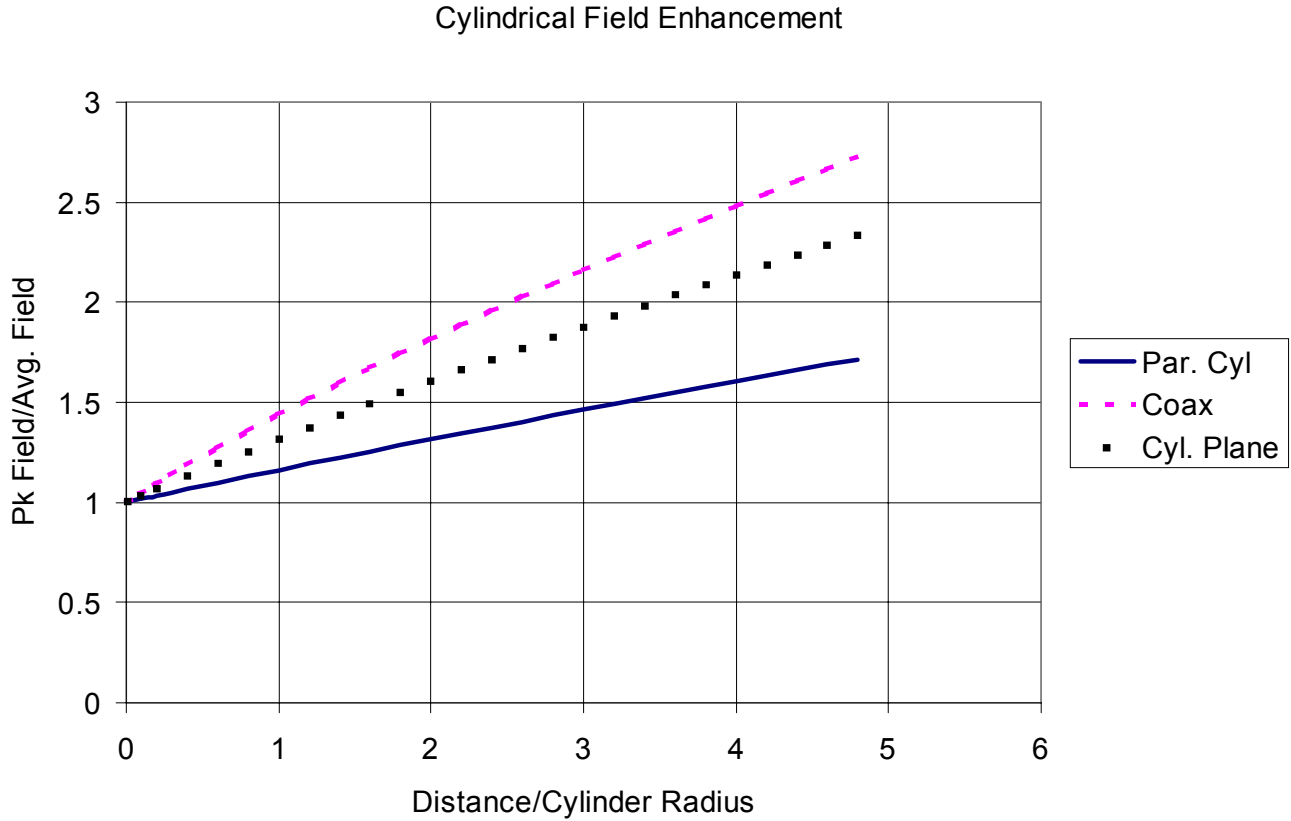

Field enhancement factor for cylindrical configurations. Upper: coaxial line, Intermediate : conducting cylinder adjacent to a plane. Lower: two parallel conducting cylinders

Maximum field strength equations for Cylindrical Geometry:

b = outer cylinder radius

$$E = V/(r \ln(b/r)) \quad \text{Concentric cylinders}$$

$$E = V(D^2 - 4r^2) / [2r(D - 2r) \ln\{(D/2r) + ((D/2r)^2 - 1)^{1/2}\}]$$

where $D = X + 2r$ for parallel cylinders, and $D = 2X + 2r$ for a cylinder spaced X from a uniform ground plane and parallel to it.

Semicylinder on a plane $E_m = 2E$ where E is the applied electric field

Spherical Geometry

Spherical Field Enhancement

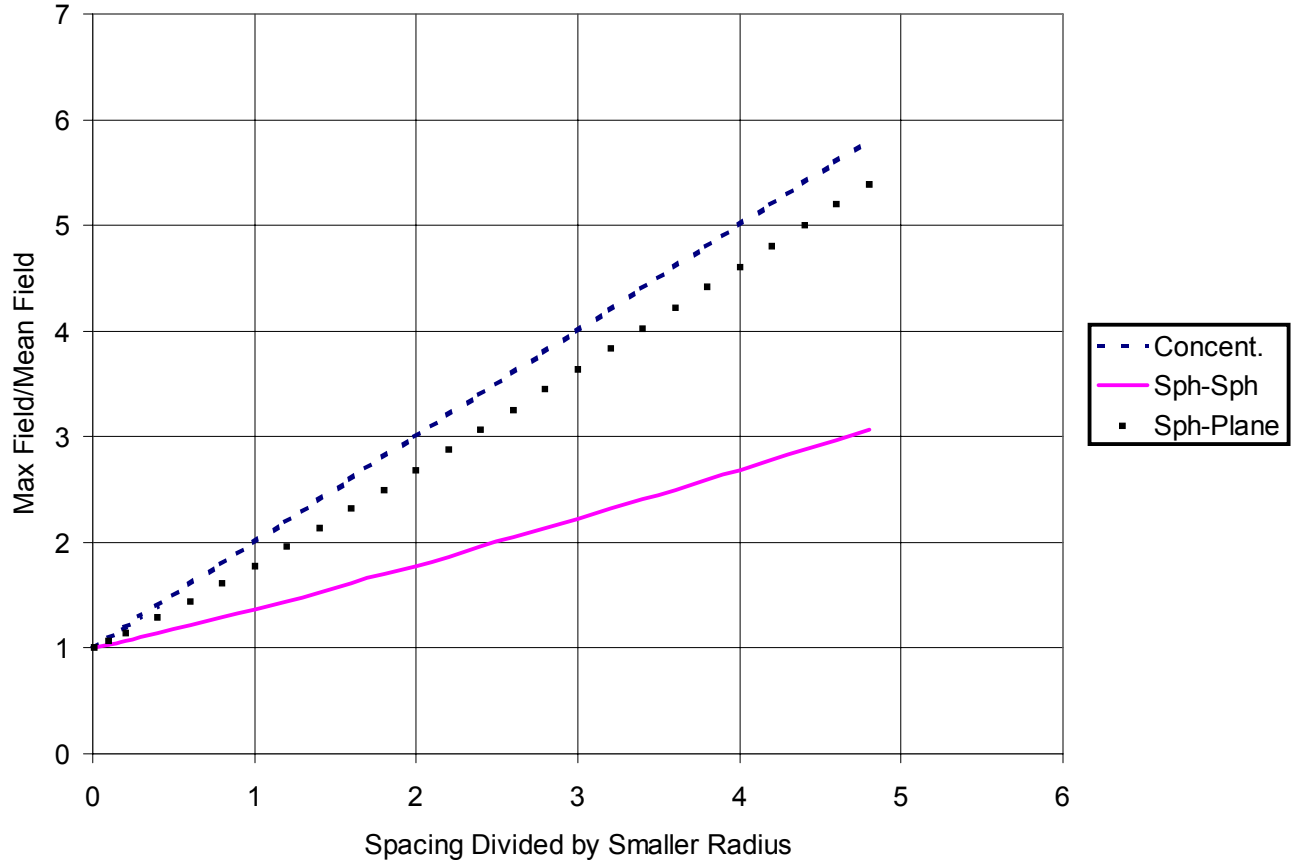

Spherical field enhancement including concentric spheres (upper) sphere-plane (middle) and adjacent spheres (lower).

Maximum field strength equations for Spherical geometry.

R = outer sphere radius
r = inner sphere radius

$E = VR/r(R-r)$ Concentric spheres

$E = V[(X/r) + 1 + ((X/r) + 1)^2 + 8]^{1/2}/4X$ Equal spheres spaced X

$E = V[(2X/r) + 1 + ((2X/r) + 1)^2 + 8]^{1/2}/8X$ Sphere of radius r spaced X from a ground plane

Hemisphere on a plane in a uniform field of amplitude E: $E_m = 3E$

6.0 MATERIALS PROPERTIES

The dielectric properties of gases and liquids are understood (empirically), and are presented as such. The typical values of dielectric strength for solids are an exception to this understanding. Solid breakdown depends on preparation, pulse life requirements, and the medium in which the solid is contained. The values quoted in this document for solid breakdown actually refer to long term working strength, and must be considered to be of limited value. Note that in general, the dielectric strength of all materials decreases with increasing sample thickness. ϵ is the relative permittivity below, and $\tan \delta$ is the energy loss per cycle.

6.1 Solid Dielectric Properties

Material	Diel. Const. 60 Hz.		Diel. Const. 1 MHz.		Diel. Strength* V/mil
	ϵ	$\tan \delta$	ϵ	$\tan \delta$	
Aluminum Oxide	8.80	3.3(-4)	8.80	320	320
Barium Titanate	1250	0.056	1143	0.0105	75
Soda-Borosilicate Glass	4.97	-----	4.84	3.6(-3)	400
Epoxy (Epon RN-48)	4.50	0.05	3.52	0.0142	800
Polycarbonate	3.17	0.009	2.96	0.01	400
Acrylic	4.0	0.016	2.55	0.009	400
Polyimide	3.4	0.002	3.4	0.003	570
Polyvinyl Chloride	3.20	0.0115	2.88	0.016	400
PTFE (Teflon)	2.10	<5(-4)	2.10	<2(-4)	550
Polyethylene	2.26	<2(-4)	2.26	<2(-4)	450
Polypropylene	2.55	<5(-4)	2.55	<5(-4)	650
Paper	3.30	0.010	2.99	0.038	200

*Typical DC values for .10 inch thick samples

6.2 Gas Properties

Gas breakdown, DC to approximately 1 microsecond

$$E = 24.5p + 6.7(p/R_{\text{eff}})^{1/2} \text{ kV/cm.} \quad \text{Air}$$

$R_{\text{eff}} = .115R$ for spheres, and $.23R$ for cylinders, and the gap distance for planar geometries, where p is the pressure in atmospheres

Resistive phase duration of an air arc

$$\tau = 88p^{1/2}/(Z^{1/3}E^{4/3}) \text{ nanoseconds}$$

where p is the pressure in atmospheres, E is the electric field in MV/m, and Z is the characteristic impedance of the circuit.

Relative electric strengths:

Relative breakdown field compared to air

Air	1.0
Nitrogen	1.0
SF ₆	2.7
Hydrogen	0.5
30% SF ₆ , 70% air (by volume)	2.0

Paschen's Law

Under most circumstances, the breakdown of gases is a function of the product of pressure (p) and gap length (d) only, where this function depends on the gas.

$$V = f(pd)$$

The breakdown strength of a gas is monotonic decreasing below a specified value of $pd = (pd)_{\text{crit}}$ and monotonic increasing above that value. The values of $(pd)_{\text{crit}}$ and the breakdown voltage at that value of pd are given below:

GAS	pd_{crit} (Torr-cm)	$V(pd_{\text{crit}})$ (Volts)
Air	0.567	327
Argon	0.90	137
Helium	4.0	156

760 Torr = 1 standard atmosphere

6.3 Liquid Breakdown

t = time that the pulse is above 63% of peak voltage (μsec)

A = Stressed area (cm^2)

d = gap between electrodes

E = Electric field (MV/cm)

Pulse Breakdown of Liquids

Transformer Oil

$$E_+ = .48/(t^{1/3} A^{.075}) \quad (\text{Positive Electrode})$$

$$E_- = 1.41E_+ \alpha \quad (\text{Negative Electrode})$$

$$\alpha = 1 + .12[E_{\text{max}}/E_{\text{mean}} - 1]^{1/2}$$

Note: The above formulae do not apply if a DC pre-stress ($> 500\text{V/cm}$) is applied across the gap

Water (areas $> 1000 \text{ cm}^2$)

$$E_+ = .23/(t^{1/3} A^{.058}) \quad (\text{Positive Electrode})$$

$E < 0.10/t^{1/2}$ is a design criterion for intermediate stores at large area

$$E_- = .56/(t^{1/3} A^{.070}) \quad (\text{Negative Electrode})$$

$$\alpha = 1 + .12[E_{\text{max}}/E_{\text{mean}} - 1]^{1/2}$$

Resistive phase rise time of a switch

$\tau_r = 5\rho^{1/2}/Z^{1/3}E^{4/3}$ where ρ (g/cm^3) is the density of the liquid, Z is the impedance of the circuit in ohms, and E is the electric field in MV/cm. This formula is thought to work for oil, water, and gas switches.

General comments on breakdown of transformer oil

Pulse power operation (typical) 100-400 kV/cm for pulsed operation with no DC prestress. The exact value is dependent on the oil, and field enhancements. For conservative DC operation 40 kV/inch is generally a reliable guideline. This value generally allows the user to ignore field enhancements and dirt when designing the DC system. If carbon streamers form in the oil during a pulse, these values no longer apply. Filtration and circulation are required in oil to avoid carbon build-ups. 40 kV/cm is a reliable number for careful DC design.

6.4 Vacuum Insulation and Surface Flashover

We assume in this section that the pressure is below 10^{-4} Torr, and note that variations due to the residual gas pressure are observed at pressures as low as 10^{-6} Torr.

- d = individual insulator length (cm.)
- A = insulator area (cm²)
- t = pulse duration or pulse train duration (μ sec)

Pulsed 45 degree acrylic insulators in vacuum

$E = 175/(t^{1/6}A^{1/10})$ kV/cm. typical for 1-2" long insulators, and more than 5 insulators

$E = 33/(t^{1/2}A^{1/10}d^{0.3})$ kV/cm for bipolar pulses

DC Flashover

Material	Electric field (kV/cm.)
Glass	$18/d^{1/2}$
Teflon	$22/d^{1/2}$
Polystyrene	$35/d^{1/2}$

Vacuum breakdown

Vacuum breakdown between parallel electrodes depends on surface preparation, pulse length electrode history, and possibly gap length, as well as material type.

We list typical values below primarily in order to give the reader an ordering of material strength. The typical voltage at which the data below is applicable is 500 kV.

Material	Pulse Breakdown (kV/cm.) 100 ns.
Aluminum	290
Graphite (Poco)	175
Lead	170
Molybdenum	460
Stainless Steel	300
Velvet cloth	20-50

A variation of breakdown strength with gap length of $d^{0.3}$ may be inferred from some data, however this effect is more pronounced in DC high voltage breakdown.

6.5 Conductor Properties

Conductivities of Conductors

Material	Density (gm/cm ³)	Resistivity(20C) (10 ⁻⁶ ohm-cm)	Ht. Cap. (J/gmC)	Temp. Coef. (1/C)
Aluminum	2.70	2.62	.946	0.0039
Beryllium	1.85	35	1.78	0.0042
Bismuth	9.80	115	0.123	0.004
Brass (66Cu,34Zn)	8.40	3.9	0.418	0.002
Chromium	7.19	2.6	0.460	
Copper	8.96	1.72	0.418	0.0039
Graphite (typical)	2.25	1400	0.894	-0.0005
Gold	19.3	2.44	0.130	0.0034
Indium	7.31	9	0.238	0.0050
Iron	7.87	9.71	0.452	0.0057
Lead	11.34	21.9	0.126	0.004
Magnesium	1.74	4.46	1.04	0.004
Nichrome (typical)	100	-----	-----	0.00017
Nickel	8.9	6.9	0.268	0.0047
Silicon	2.4	85,000	0.736	-----
Silver	10.5	1.62	0.234	0.0038
Stainless Steel	7.90	90	-----	-----
Steel (.5%C)	7.90	13-22	0.520	0.003
Tantalum	16.6	13.1	0.151	0.003
Tin	7.3	11.4	0.226	0.0042
Titanium	4.54	47.8	0.594	-----
Tungsten	19.3	5.48	0.142	0.0045

6.5.1 Wire Data--Standard Sizes of Copper Wire

AWG B&S GAUGE	DIAM. (MILS)	OHMS PER 1000 FT	LB. PER 1000 FT
0000	460	.049	640
000	410	.062	509
00	365	.078	403
0	324	.099	318
1	289	.124	253
2	257	.157	200
3	229	.198	159
4	204	.249	126
5	182	.313	100
6	162	.395	79.4
7	144	.500	62.8
8	128	.633	49.6
9	114	.798	39.3
10	102	.997	31.5
11	90.7	1.26	24.9
12	80.8	1.59	19.8
13	72.1	1.99	15.7
14	64.1	2.52	12.4
15	57.1	3.18	9.87
16	50.8	4.02	7.81
17	45.3	5.05	6.21
18	40.3	6.39	4.92
19	35.9	8.05	3.90
20	31.2	10.7	2.95
21	28.5	12.8	2.46
22	25.4	16.1	1.95
23	22.6	20.3	1.55
24	20.1	25.7	1.22
25	17.9	32.4	.970
26	15.9	41.0	.765
27	14.2	51.4	.610
28	12.6	65.3	.480

6.6 Magnetic materials

Material	Sat. flux kG B_s	Res. Flux kG B_r	Init. perm. DC μ_i	Max. perm. DC μ_m	Resistivity ohm-cm ρ
Metglas					
2605SC	16.1	14.2	8,000	300,000	142(-6)
2605CO	18.0	16.0	5,000	250,000	160(-6)
3% Si-Fe	16.5	14-15	500	25,000	50(-6)
Permalloy	7.5	6.0	20,000	150,000	45(-6)
50% Ni-Fe	16.0		2,500	25,000	45(-6)
NiZn Ferrite					
CN20*	3.8	2.7	800	4,500	1(6)
MnZn Ferrite					
3C80**	5.0	1.6	2,000		4.8
MN80*	5.0	2.5	1,500	5,000	200

Note that the data above are applicable for low frequencies, and the performance at higher frequencies is dependent on frequency. Metal materials must be wound in thin insulated tapes for most pulse power applications. * Ceramic Magnetics ** Ferroxcube

6.6 Components

6.6.1 Capacitors

N = number of pulses to failure

E = Electric field in application

V_b = DC breakdown voltage

d = dielectric thickness

Q = circuit quality factor

β = thickness exponent, typically less than 3

V_r = reversal voltage

$N \propto (Ed/V_b)^{-8} d^{-\beta} Q^{-2.2}$ for plastic capacitors

$N \propto (Ed/V_b)^{-12} Q^{-2.2}$ for ceramic capacitors

$V_r = 1 - \pi 2Q$

Notes: Barium Titanate capacitors--unless specially prepared--vary in capacitance by about a factor of 2 over their range of voltage utilization

Mica capacitors have an excellent combination of dissipation factor, and low change in value under voltage and temperature stress, but only at high cost.

Paper and plastic capacitors can have significant internal inductance and resistance, and these quantities must be ascertained in any critical application. In practice it is nearly impossible to discharge any paper or plastic capacitor in less than 100 ns, and many capacitors may take much longer to discharge.

6.6.2 Resistors

General comments on performance under pulse power conditions.

Carbon composition resistors have excellent performance in voltage and power handling, but may have resistance variations with voltage of 2 -50 % depending on type, history, etc.

Metal film resistors must be specially designed for high voltage and pulse power use. The pulse energy handling capability of film resistors is generally inferior to that of bulk resistors due to the relatively small mass of the current carrying component.

Liquid resistors such as water/copper sulphate, etc, are subject to variation in resistivity with time. The preferred method for measuring the resistance of these components is with a pulsed high voltage (measuring current for a known voltage). DC measurements at low voltage can often be wrong by factors of 2 or 3.

7.0 APPLICATIONS

7.1 Intense Electron and Ion Beam Physics

Space charge limited electron emission current, or 'Child-Langmuir' current density

V = Voltage applied in MV

d = gap between anode and cathode in cm.

$$J_s = \text{Current density} = 2.34V^{3/2}/d^2 \text{ kA/cm}^2 \text{ for } V < .5 \text{ MV}$$

$$J_s = 2.7[(V/0.51 + 1)^{1/2} - 0.85]^2/d^2 \text{ kA/cm}^2 \text{ for } V > .5 \text{ MV}$$

Bipolar flow in an anode-cathode gap where the anode is also a source of space charge limited ions

$$J = 1.84 J_s \text{ (} V < .5 \text{ MV)}$$

$$J = 2.14 J_s \text{ (} V > .5 \text{ MV)}$$

Typical thermionic emitter data

Material	efficiency (mA/watt)	Typ. J (amps/cm ²)	Temperature (Kelvin)	hot R/cold R R = Resistance
Tungsten	5-10	.25-.7	2550	14/1
Th-W	40-100	0.5 - 3.0	2000	10/1
Tantalum	10-20	0.5-1.2	2450	6/1
Oxide	50-150	0.5-2.5	1100	-----
Dispenser	100-2000	1.0-25	1400	-----
LaB ₆	200-500	1.0-60	1970	-----

Vacuum beam propagation

Space charge limiting current

b = beam conducting drift tube diameter
a = beam outer diameter
f = ratio of ion to electron densities
g = ln(b/a) for annular beams
= 1/2 + ln(b/a) for solid beams
 $\alpha = 1 + ea \delta B/mc = 1 + a \delta B/1.7$
 δB = change in magnetic field (kG in numerical formula)
giving rise to rotation
 $\gamma = 1 + V/0.51 = 1/(1-\beta^2)^{1/2}$ = relativistic factor
 $\beta = v/c$ = normalized beam velocity
 $I_0 = 4\pi mc/\mu_0 e = 17,000$ amperes

$$I < 17(\gamma^{2/3} - \alpha^{2/3})^{3/2} / (1-f)g \text{ kiloamperes}$$

Uniform beam spread curve

$K = (2I/17\beta^2 \gamma)[1/\gamma^2 - f]$
 $\alpha = dr/dz$
 a_0 = initial beam radius

$$r/a_0 = \exp(\alpha^2/2K)$$

Beam equilibrium condition

$$I < 0.7\beta_p B^2 a^2 \gamma \text{ kA}$$

β_p is the component of β in the direction of beam propagation, B is in kG, and a is in cm.

Magnetic field energy required to focus a beam in equilibrium (note that this may not assure stability)

k_1 = ratio of field coil radius to beam radius
 k_2 = ratio of field to minimum field
 k_3 = ratio of field energy inside coil radius to field energy
outside coil radius
 l = length of field region (cm.)
E = Energy of magnetic field (joules)
 $E = .036ll k_1^2 k_2^2 k_3 / \beta_p \gamma$

Beam rotation

$$\omega_c = 2\pi f_c = eB/\gamma mc = 17B/\gamma \text{ Ghz.} = \text{cyclotron angular frequency}$$

where B is in kG

$$r_L = \beta c/\omega_c = 1.7(\gamma^2 - 1)^{1/2}/B \text{ cm.}$$

Cusp Condition

$$\delta B = B_{\text{initial}} - B_{\text{final}} \text{ in kilogauss}$$

$$r < 3.4 (\gamma^2 - 1)^{1/2} / \delta B$$

Magnetic Insulation

$$d = \text{anode-cathode gap in cm. for planar geometry} \\ = (b^2 - a^2)/2a \text{ in cylindrical geometry (b=OD, a=ID)}$$

$$B > (1.7/d)(\gamma^2 - 1)^{1/2} \text{ kG}$$

Self magnetic insulation

$$\text{Minimum current} = I = 8.5(\gamma^2 - 1)^{1/2} / \ln(b/a) \text{ kiloamps}$$

$$= (I_0/2)(\gamma^2 - 1)^{1/2} / \ln(b/a)$$

7.2 Electron Beam/Matter Interaction

Stopping Power and Range

Note that electron beams do not have a well defined stopping point in material. The CSDA range follows the path of an electron ignoring scattering, and is the longest distance an electron can physically travel. The practical range is the linear extrapolation of the depth-dose curve and indicates a point where the electron flux is a few percent of the incident flux. Electron ranges and stopping powers are approximately proportional to the electron density in the medium.

Electron energy (MeV)	CSDA Range in Al. gm/cm ²	Practical Range in Al. g/cm ²
.1	.018	0.009
.5	.25	0.16
1.0	.61	0.42
2.0	1.33	0.95
5.0	3.3	2.40
10.0	6.1	5.0

Radiation production with electron beams

100 ergs/gram = 1 Rad 10 Joules/gram = 1 MRad

For 1-10 MeV Aluminum, 1 μ Coulomb/cm² \simeq 0.2 megarads on average over the range

X-ray production efficiency

V = beam energy in megavolts
 Z = Target atomic number
 I = Beam current in kiloamperes

(X-ray energy total/Beam energy) = $7(-4)ZV$

Dose rate D(rads/sec) at 1 meter directly ahead of the beam

$D = 1.7(6)IV^{2.65}$ for Z = 73

Blackbody Radiation Law

T = Temperature (Kelvin)
 ϵ = Emissivity of surface
 Radiation flux = $5.67(-8)\epsilon T^4$ W/m²

7.3 High Power Microwaves

$f(c)$ =frequency (of cutoff)

c =speed of light= 3.0×10^8 m/sec

λ_g =waveguide wavelength

$\omega=2\pi f$

$k=2\pi/\lambda_g$

Frequency Band Designations:

Tri-Service F(Ghz.)	World War II Designation	F(Ghz.)	Designation	Waveguide
0.0-.25	A	.003-.030	HF	
.25-.50	B	.030-.300	VHF	
.50-1.0	C	.300-1.12	UHF	
1.0-2.0	D	1.12-1.76	L	WR650
2.0-3.0	E	1.76-2.60	LS	WR430
3.0-4.0	F	2.60-3.95	S	WR284
4.0-6.0	G	3.95-5.89	C	WR187
6.0-8.0	H	5.89-8.20	XN	WR137
8.0-10.0	I	8.20-12.9	X	WR90
10.0-20.0	J	12.9-18.0	Ku	WR6
20.0-40.0	K	18.0-26.5	K	WR42

Waveguide Relations

$$f^2 = f_c^2 + (c/\lambda_g)^2$$

Rectangular Waveguide, dimensions a, b, a>b

$$\lambda_g = 2a \text{ TE}_{01}, \lambda_g = 2a/(1+(a/b)^2)^{1/2} \text{ TE}_{11}, \lambda_g = 2a/(1+(a/b)^2)^{1/2} \text{ TM}_{11},$$

$$\lambda_g = 2a/(1+(a/2b)^2)^{1/2} \text{ TE}_{21}, \lambda_g = 2a/(1+(a/2b)^2)^{1/2} \text{ TM}_{21},$$

Circular Waveguide, a=radius

$$\lambda_g = 1.640a \text{ TE}_{01} \quad \lambda_g = 2.613a \text{ TM}_{01}$$

$$\lambda_g = 3.412a \text{ TE}_{11} \quad \lambda_g = 1.640a \text{ TM}_{11}$$

7.4 Railguns

Capacitor - Driven Rail Gun Circuit

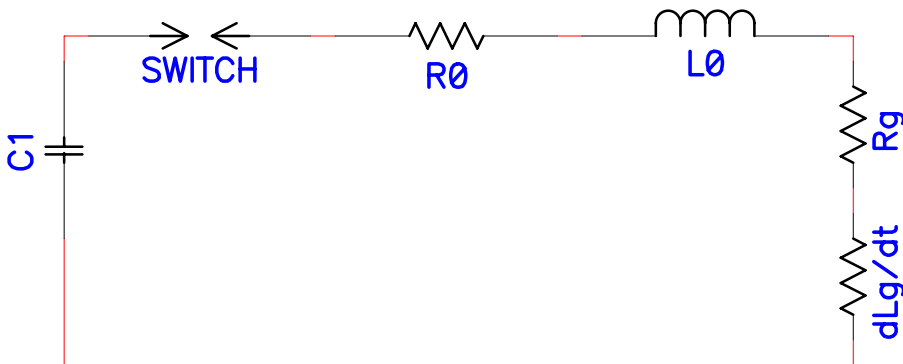

$$\text{Voltage: } (L_o + L_G)d^2q/dt^2 + (R_o + R_G + (dL_G/dx)v)dq/dt + q/C = V_o$$

$$\text{Eq. of Motion: } (m_p + (dm_a/dx)x)d^2x/dt^2 = (1/2)(dL_G/dx)(di/dt)^2 - (dm_a/dx)(dx/dt)^2$$

$$\text{Electrode pressure: } P = (1/2)((dL_G/dx)/A)i^2$$

$$\text{for } dm_a/dx = 0, i = \text{constant: } v = [(dL_g/dx)ix/m_pA]^{1/2}$$

$$R_G = R_{G0} + (dR_G/dx)x$$

$$\text{for } m = 0, i = \text{Iexp}(-\alpha t \sin \omega t), L_G = L_{G0} + L_G x$$

- C = driver capacitance
- R_o = driver resistance (fixed)
- L_o = driver inductance (fixed)
- q = charge
- A = cross-sectioned gun area
- dR_G/dx = gun longitudinal resistance gradient
- dL_G/dx = gun longitudinal inductance gradient
- x = Longitudinal distance
- v = Longitudinal projectile relocity
- m_p = projectile mass
- dm_a/dx = longitudinal air mass gradient

Ablation rate constants (Jerall V. Parker, Proceedings at the IEEE 3rd Symposium on Electromagnetic Launch Technology, Austin, TX, 1988)

Gun Mode

Material	Ablation	Vaporization	Erosion (gas - liquid)
Copper	28 g/MJ	118 g/MJ	143 - 1630g/MJ
Tungsten	88	160	185 - 1575
Polyethylene	3.4	25	500 - 6,800
Lexan	5.6	40	
G-10	6.7	40	

8.0 DIAGNOSTICS

8.1 Sensitivity of an Unintegrated Square Current Loop

b = outer conductor distance to current source center(m)

a = inner conductor distance to current source center(m)

l = length of current loop(m) parallel to current axis

N = number of turns in the current loop

$$V_{\text{out}} = (\mu_0 l N / 2\pi) \ln(b/a) (dl/dt)$$

Integrated using a passive RC integrator

$$V_{\text{out}} = (\mu_0 l N \ln(b/a) / 2\pi RC) I$$

$$= 2Nl (\ln(b/a) / RC) I \quad l \text{ is in cm., } I \text{ in kA, } RC \text{ in } \mu\text{sec}$$

R = resistance of the RC integrator

C = capacitance of the RC integrator

RC product in seconds or microseconds as appropriate above

I = current to be measured

8.2 Rogowski Coil

The Rogowski coil consists of N turns wound on a form circular in shape evenly along the major circumference. Each turn has an area A. The major circumference has a radius ρ , and the output is independent of the relative position of the current flow as long as the winding source is more than 2 turn spacings away from the current source.

ρ = major radius of the Rogowski coil

$$V_{\text{out}} = (\mu_0 NA / 2\pi\rho) dl/dt \quad \text{unintegrated}$$

$$V_{\text{out}} = (\mu_0 NA / 2\pi\rho RC) I \quad \text{integrated}$$

$$= (2NA / \rho RC) I \quad \text{integrated } A(\text{cm}^2), \rho(\text{cm}), RC(\mu\text{sec}), I(\text{kA})$$

$$= (12.63nA / RC) I \quad \text{integrated } A(\text{cm}^2), RC(\mu\text{sec}), n(\text{cm}^{-1})$$

8.3 Current Transformer

Given appropriate frequency response in the core, a current transformer will give linear output over a wide range of time scales and currents.

- R = total terminating resistance of the measurement circuit
- b = od of square core
- a = id of square core
- l = length of square core
- δB = saturation magnetization of core
- N = number of turns
- μ_o = Permeability (H/m)

$$V_{out} = (R/N)I$$

$$Z = R/N^2 = \text{insertion impedance of the current transformer}$$

$$\tau = \mu N^2 l \ln(b/a) / R = \text{exponential decay time of signal}$$

$$I_{max} \tau_{max} = N^2(b-a)l \delta B / R$$

The risetime of current transformers is generally determined empirically

8.4 Attenuators

T-pad type attenuators are commonly used in fixed impedance (typically 50 ohm) systems. We list the general equation for this type of attenuator, and several standard values.

- Z = characteristic impedance
- K = attenuation factor (>1)
= voltage out/voltage in

$$R_1 = Z[1 - 2/(K+1)]$$

$$R_2 = 2ZK/(K^2 - 1) \quad A = 20 \text{ Log}_{10}(K) = 10 \text{ Log}_{10}(\text{Power in/Power out}) = \text{attenuation in db}$$

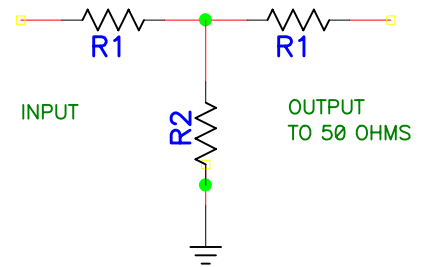

50 ohm attenuator combinations

K	R ₁	R ₂
2	16.7	66.7
5	33.3	20.8
10	43.9	10.1

9.0 MECHANICAL DATA

9.1 Coarse Screw Threads

Size	Thds. per inch	Major diam. (inches)	Minor diam. (inches)	Lead Angle	
				(deg.)	(min.)
1	64	0.073	0.056	4	31
2	56	0.086	0.067	4	22
3	48	0.099	0.076	4	26
4	40	0.112	0.085	4	45
5	40	0.125	0.098	4	11
6	32	0.138	0.101	4	50
8	32	0.164	0.130	3	58
10	24	0.190	0.145	4	39
12	24	0.216	0.171	4	1
1/4	20	0.250	0.196	4	11
5/16	18	0.313	0.252	3	40
3/8	16	0.375	0.307	3	24
7/16	14	0.438	0.360	3	20
1/2	13	0.500	0.417	3	7
9/16	12	0.563	0.472	2	59
5/8	11	0.625	0.527	2	56
3/4	10	0.750	0.642	2	40
7/8	9	0.875	0.755	2	31
1	8	1.000	0.865	2	29

9.2 Fine Threads

Size	Thds. per inch	Major diam. (inches)	Minor diam. (inches)	Lead Angle	
				(deg.)	(min.)
0	80	0.060	0.465	4	23
1	72	0.073	0.058	3	57
2	64	0.086	0.069	3	45
3	56	0.099	0.080	3	43
4	48	0.112	0.089	3	51
5	44	0.125	0.100	3	45
6	40	0.138	0.111	3	44
8	36	0.164	0.134	3	28
10	32	0.190	0.156	3	21
12	28	0.216	0.177	3	22
1/4	28	0.250	0.211	2	52
5/16	24	0.313	0.267	2	40
3/8	24	0.375	0.330	2	11
7/16	20	0.438	0.338	2	15
1/2	20	0.500	0.446	1	57
9/16	18	0.563	0.502	1	55
5/8	18	0.625	0.565	1	43
3/4	16	0.750	0.682	1	36
7/8	14	0.875	0.798	1	34
1	12	1.000	0.910	1	36

9.3 Deflection of Beams

Rectangular Beams, d=vertical direction, l=length, b=wide direction, all units in inches,
 E=Elastic Modulus (lb/in²)
 W=Weight supported (pounds), h=deflection

<u>Supported at both ends,</u>	Uniform load	$h=5Wl^3/32Ebd^3$
<u>Fixed at both ends,</u>	Uniform load	$h= Wl^3/32Ebd^3$
<u>Supported at both ends,</u>	Center load	$h= Wl^3/4Ebd^3$
<u>Fixed at both ends,</u>	Center load	$h= Wl^3/16Ebd^3$

Deflection of Circular flat plates, R=radius(inches), W=total load (pounds), t=thickness (inches)

<u>Edges supported,</u>	Uniform load	$h=0.221 WR^2/Et^3$
<u>Edges fixed,</u>	Uniform load	$h=0.054 WR^2/Et^3$
<u>Edges supported,</u>	Center load	$h=0.55 WR^2/Et^3$
<u>Edges fixed</u>	Center load	$h=0.22 WR^2/Et^3$

Metric Note: The formulae above also apply if the lengths are in meters, the weights are in kilograms, and the elastic modulus is in kg/m².

Modulus of elasticity

Material	Elasticity (Millions of lb/in ²)
Steel, (typical)	30
Steel, Stainless	28
Aluminum (most types)	10.3
Brass (typical)	15
Titanium	16
Acrylic	0.40
Nylon	0.30
Polyimide	0.37
Alumina	41
Wood	1.4 - 2.3

10.0 REFERENCES

These references are intended to reflect useful references in the field, and they might form a basic library. A short computerized database of references for this formulary is available (for the cost of postage and handling) from North Star Research Corporation.

1. D.L. Book, NRL Plasma Formulary, (Laboratory for Computational Physics, Naval Research Laboratory, Washington, 1983).
2. W.J. Sarjeant and R.E. Dollinger, High Power Electronics, (TAB Books, Blue Ridge Summit, PA, 1989).
3. G.N. Glasoe and J.V. Lebacqz, Pulse Generators, (Dover, New York, N.Y, 1948).
4. H.W. Sams & Co., Reference Data For Radio Engineers, Sixth Edition, (Howard W. Sams & Co., Inc., Indianapolis, Indiana, 1975).
5. C.E. Baum, Dielectric Strength Notes, AFWL Report PEP 5-1, (Air Force Weapons Laboratory, Albuquerque, NM, 1975).
6. E. Oberg, F.D. Jones, and H.H. Horton, Machinery's Handbook, 23rd Edition (Industrial Press, New York, N.Y, 1988).
7. S. Humphries, Jr., Principles of Charged Particle Acceleration, (Wiley, New York, N.Y. 1986).

Errata, and correspondence regarding additional copies, large format copies of the formulary or database disks should be addressed to:

North Star Research Corporation
4421 McLeod, NE, Ste. A
Albuquerque, NM, 87109

Attn: Formulary

Copies from the initial vest pocket printing are free while supplies last, but additional copies, or the related materials may be subject to handling charges.

Fundamental constants:

E.R. Cohen, and B.N. Taylor, *Physics Today*, 40, BG3 (1989).

References: *Solid Breakdown, Reference Data For Radio Engineers*, Howard W. Sams & Co. New York, 6th. Edition, 1982. *Plastics Reference Handbook*, Regal Plastics

Alberox Corp. Tech. Data

Gas Breakdown--Alston (DC)

DC flashover from Hackam

Conductor resistivities, densities, etc. from

Ref. Data Rad. Eng.,
Machinery's Handbook,
Std. Handbook For EE

CSDA Electron Range

L. Pages et. al. *Atomic Data* Volume 4, p. 1